



Preface











- Thank you for using Shepherd 240 Biometric Fingerprint Lock.
- Please read this Installation Manual carefully before attempting to install your new lock. This manual covers installation procedures.
- Manufacture, or their representative, will not be responsible for any damages caused by incorrect installation or mishandling of the lock. Any such damages will void manufacture's warranty.

Table of Contents

Preface.....	1
Table of Contents.....	2
1. Identifications.....	3
2. Required tools.....	4
3. Pre installation	
3.1 Locating hole center from the edge of the door.....	5
3.2 Deadbolt adjustment.....	6
4. Installation	
4.1 Deadbolt installation.....	7
4.2 Installation of Deadbolt Strike and Strike Lining Box.....	8
4.3 Sizing torque bar.....	9
4.4 Installation of the outside Lock.....	10
4.5 Installation of Inside Lock.....	11
4.6 Tightening Screws.....	13
4.7 Final inspection/adjustment prior saving fingerprint.....	14
5. Problems / Solution	15

1. Identifications

Please familiarize yourself with all the parts. If any part is missing or damaged, contact our service center or manufacture immediately.

		
Inside Lock Assembly	Outside Lock Assembly	Outside Rubber Seal
		
Inside Rubber Seal	Deadbolt	Strike Lining Box
		
Deadbolt Strike	Overriding Keys	Attaching Screws
		
Wooden Screws	Machine Screw	

2. Required Tools

1. Electric or battery operated Drill	2. One 3/8" Diameter Drill Bit
3. One 1" Diameter. Drill bit	4. One 2 1/8" Diameter Drill Bit
5. A Carpenter Chisel	6. A Hammer
7. A pair of scissors	8. A pair of pliers
9. Philips & flat head screw drivers	

3. Pre installation

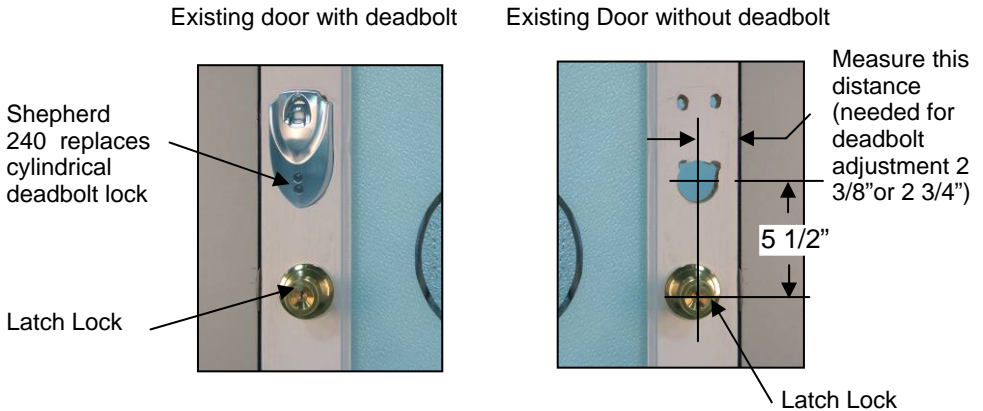

3.1 Locating hole center from the edge of the door



Door with existing cylindrical deadbolt lock: Remove existing cylindrical deadbolt and install the new Shepherd 240 in its place per Section 4 and paper template.

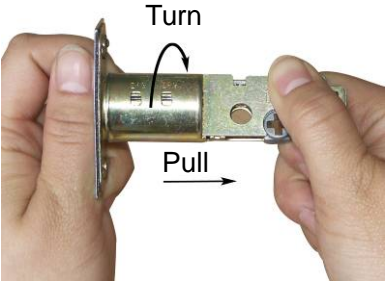

Door that does not have a cylindrical deadbolt lock nor a hole for the cylindrical deadbolt lock: Mark the center of the new hole by measuring the distance from the edge of the door to the existing latch lock center; door with one hole measure the distance from the edge of the door to the center of the hole. It should measure either 2 3/8" or 2 3/4" (American door lock standard). This distance dictates the length of the deadbolt see section 3.2.

3.2 Deadbolt adjustment

	<p>1. Manufacture setting is 2 3/8" shown on deadbolt.</p>
	<p>2. If 2 3/4" is needed, turn and pull as shown.</p>
	<p>3. Make sure it clicks and the number matches the measurement you obtained from section 3.1.</p>

4. Installation

4.1 Deadbolt installation

	
<p>1. Insert the deadbolt from the side of the door (follow the “UP ↑” sign). Mark the edges. Then carve out 1/8” deep rectangular shape, per your marking, using chisel and hammer.</p>	<p>2. Insert the deadbolt; make sure the deadbolt “UP ↑” sign is up. Then screw it to the door.</p>

4.2 Installation of Deadbolt Strike (on the door) and Strike Lining Box (on the door frame).



Install Deadbolt Strike Lining Box by aligning the deadbolt on door with the frame. Make a deep enough cutout with chisel and hammer, to accept the Strike Lining Box.



Install the Strike Lining Box and screw it to the frame using provided wooden screws.

4.3 Sizing Torque Bar (to the right length)

Shepherd 240 is designed to fit door thickness of 1 3/8" to 2"

TRIM TORQUE BAR PER DOOR THICKNESS

(Door thickness 1 3/8" to 2")

Use full length if door thickness is 2"

Trim here if door thickness is 1 3/8 to 1 1/2"

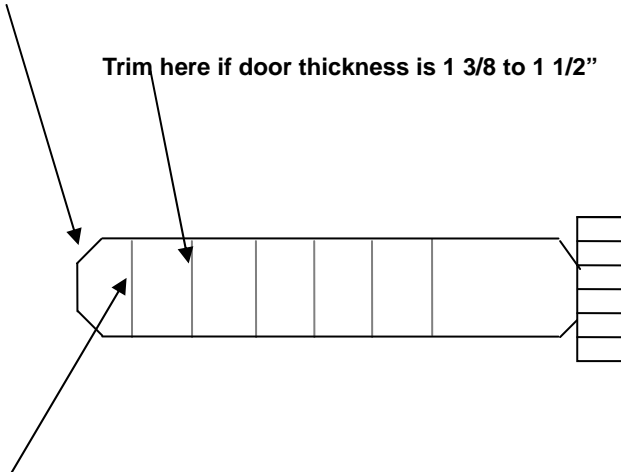



Trim here if door thickness is 1 3/4"

Trim the torque bar accordingly, with a pair of pliers.

Note: If the door thickness falls between 2 notches. Go to next higher.

(Sketch is not to scale)

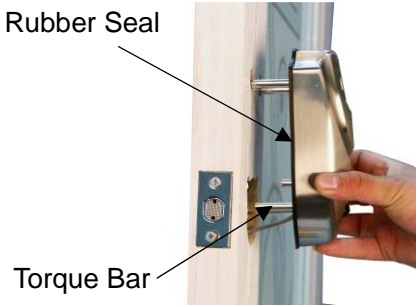
4.4 Installation of the outside Lock (which contains the finger scanner)

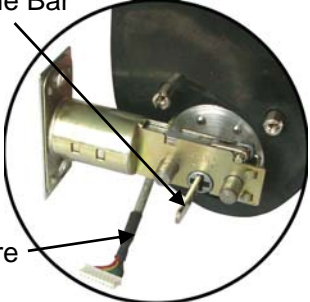
 <p>Rubber Seal</p> <p>Torque Bar</p>	<ol style="list-style-type: none">1. Place the rubber seal to the back of the outside lock.2. Push deadbolt inside the door.3. Make sure the torque bar is vertical.4. Insert torque bar through the cross slot of the deadbolt.
	<ol style="list-style-type: none">1. Insert the connector and wire under the deadbolt.2. Insert the two poles through corresponding holes on the door (the newly drilled holes).3. Temporarily tape the outside lock to the door. Remove tape once installation is complete.
 <p>Torque Bar</p> <p>Wire</p>	<p>Locate connecting wire under the deadbolt assembly.</p>

4.5 Installation of Inside Lock



1. Place rubber seal on the back of the inside lock.

2. Connect the 2 sets of wire (it only goes one way) by holding the insulated portion of the wires. It should end up as shown in the view to the left.

3. Turn the knob to the open position (vertically, the dot on the knob must be on top).

4. Insert the torque bar through the cross slot of the deadbolt and the slot of the inside lock.

5. Push gently, sandwiching the door.

6. Turn the knob to insure the operation of the deadbolt.





7. Continuously check the operation of the knob.



IMPORTANT

Please make sure the fat end of the knob is pointing upward. (The dot that number 3 on page 11 is referring to should have been on top of the fat end but was left out)

4.6 Tightening Screws

	<p>Use the 1 1/8" screws through the battery compartment affix the screws to outside lock.</p>
	<p>Use the 3 1/8" screws through the bottom holes of the inside lock. Slightly tighten the screws to the front lock two screw holes. Recheck by turning the knob to horizontal position, and then to vertical position if it feels right, tighten the screws.</p>

4.7 Final inspection/adjustment prior saving fingerprint

Note: After installation and prior to using the unit, make sure you read and follow the steps below:

1. Insert 4 new long life AA batteries in the battery compartment.

2. Turn the inside knob to the vertical position. The dot must be on top (unlock position); next turn it to the horizontal position (locked position). It should turn freely.
If and when the inside and outside locks are attached securely and the inside knob doesn't turn freely, see the problem and solution table below for possible solution. If the knob turns freely, continue with the next step.

3. Program the unit to work on right or left hand door:
Make sure the inside knob is in vertical and the dot is on top (unlocked position).
Press and hold the delete button and with the other hand press the power on button, if the deadbolt protrudes outward, you programmed the unit successfully.
If it does not, press and hold the save button and with the other hand press the power on button, the dead bolt will protrude outwardly, indicating successful configuration.

4. Try to lock and unlock from outside by pressing the power on button. The unit should lock and when pressed again it should unlock.

5. Problem/Solution

Problems / Solution Table

PROBLEMS	POSSIBLE REASONS	SOLUTIONS
Inside knob does not turn or turns very sluggishly & hard to turn.	<ol style="list-style-type: none"><li data-bbox="362 472 618 501">1. Incorrect installation.<li data-bbox="362 766 618 833">2. Torque bar not trimmed properly.	<ol style="list-style-type: none"><li data-bbox="645 472 1012 708">1. Make sure the torque bar was trimmed and inserted vertically through the cross slot of the deadbolt and the slot of the inside lock while the inside knob was vertical, with the dot on top.<li data-bbox="645 766 1012 916">2. Measure the door thickness and trim the torque bar per section 4.3 of the installation manual.
Inside knob turns but nothing happens	<ol style="list-style-type: none"><li data-bbox="362 979 618 1091">1. Torque bar did not go through the cross slot of the dead bolt.<li data-bbox="362 1232 618 1382">2. Torque bar was trimmed too short and does not penetrate the slot of the inside lock	<ol style="list-style-type: none"><li data-bbox="645 979 1012 1216">1. Remove & reinstall the outside lock. Insert the torque bar through the cross slot of the deadbolt and slot of inside lock knob while the knob is in vertical position with the dot on top.<li data-bbox="645 1273 1012 1340">2. Contact service center or the Manufacture.

<p>When Power on button is pressed and the deadbolt does not protrude outwardly. Instead, 6 alert beeps are heard.</p>	<p>1. Right & Left hand door configuration is incorrect.</p> <p>2. The dot on the Inside knob was on the bottom instead of up.</p>	<p>1. Correctly configured the unit for right or left hand door swing per section 4.7 No. 3 shown above.</p> <p>2. Uninstall and reposition the knob vertically with the dot on top.</p>
<p>When Power on button is pressed while the door is closed but does not lock, Instead 6 alert beeps are heard.</p>	<p>1. Improper positioning of the Deadbolt Strike and Strike Lining Box. It may be deflecting the deadbolt.</p> <p>2. Deadbolt length not set properly.</p>	<p>1. Check the position of the Deadbolt Strike and Strike Lining Box.</p> <p>2. Readjust the deadbolt length make sure the deadbolt is clicked in the 2 3/8" or 2 3/4" position.</p>
<p>The system does not respond when pressing the power on/off button (lights do not turn on or off).</p>	<p>1. Batteries inserted incorrectly.</p> <p>2. Inside and outside Lock assembly wire not connected properly.</p>	<p>1. Remove & reinsert batteries follow the "+" and "-" signs in the battery compartment.</p> <p>2. Check the connections make sure both wires are coupled properly.</p>
<p>When pressing the power on button (with the door open or closed) the red light blinks 3 times with 6 alert beeps.</p>	<p>Low Voltage.</p>	<p>Replace batteries with 4 new long life AA batteries.</p>